

HIKVISION
HiWatch Series

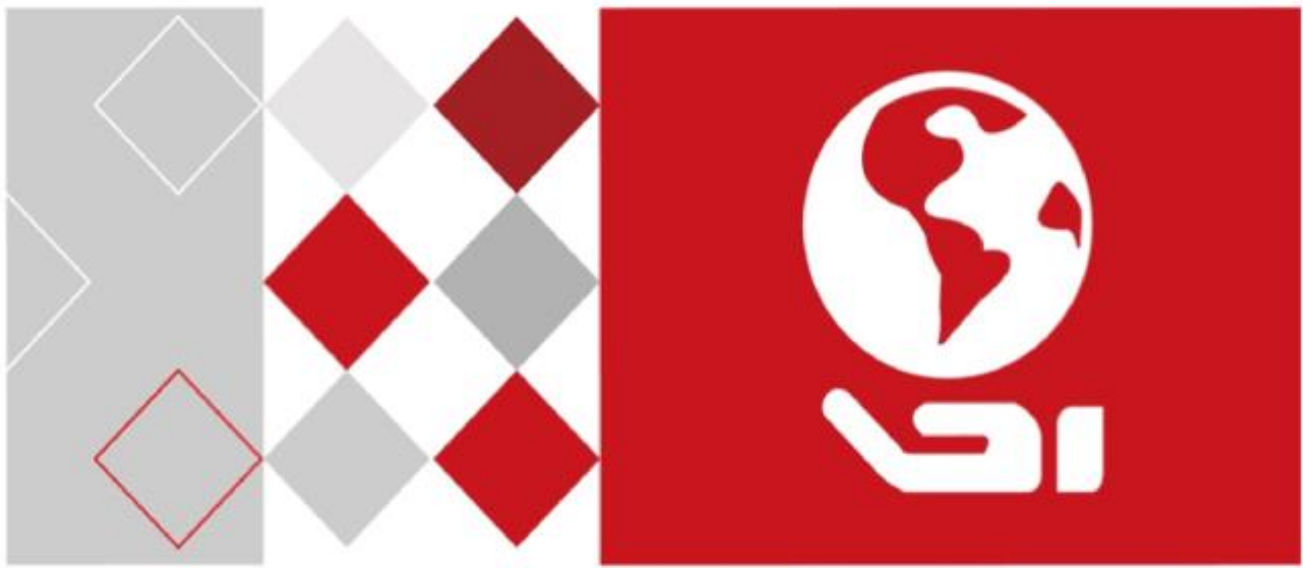

Network Video Recorder

Quick Start Guide

Legal Information

©2020 Hangzhou Hikvision Digital Technology Co., Ltd. All rights reserved.

About this Manual

This Manual is applicable to Network Video Recorder (NVR).

The Manual includes instructions for using and managing the product. Pictures, charts, images and all other information hereinafter are for description and explanation only. The information contained in the Manual is subject to change, without notice, due to firmware updates or other reasons. Please find the latest version in the company website (<https://www.hi-watch.eu/>).

Please use this user manual under the guidance of professionals.

Trademarks Acknowledgement

HIKVISION

HiWatch Series

and other Hikvision's trademarks and logos are the properties of Hikvision in various jurisdictions. Other trademarks and logos mentioned below are the properties of their respective owners.

HDMITM

HIGH-DEFINITION MULTIMEDIA INTERFACE

The terms HDMI and HDMI High-Definition Multimedia Interface, and the HDMI Logo are trademarks or registered trademarks of HDMI Licensing Administrator, Inc. in the United States and other countries.

Legal Disclaimer

TO THE MAXIMUM EXTENT PERMITTED BY APPLICABLE LAW, THE PRODUCT DESCRIBED, WITH ITS HARDWARE, SOFTWARE AND FIRMWARE, IS PROVIDED "AS IS", WITH ALL FAULTS AND ERRORS, AND HIKVISION MAKES NO WARRANTIES, EXPRESS OR IMPLIED, INCLUDING WITHOUT LIMITATION, MERCHANTABILITY, SATISFACTORY QUALITY, FITNESS FOR A PARTICULAR PURPOSE, AND NON-INFRINGEMENT OF THIRD PARTY. IN NO EVENT WILL HIKVISION, ITS DIRECTORS, OFFICERS, EMPLOYEES, OR AGENTS BE LIABLE TO YOU FOR ANY SPECIAL, CONSEQUENTIAL, INCIDENTAL, OR INDIRECT DAMAGES, INCLUDING, AMONG OTHERS, DAMAGES FOR LOSS OF BUSINESS PROFITS, BUSINESS INTERRUPTION, OR LOSS OF DATA OR DOCUMENTATION, IN CONNECTION WITH THE USE OF THIS PRODUCT, EVEN IF HIKVISION HAS BEEN ADVISED OF THE POSSIBILITY OF SUCH DAMAGES.

REGARDING TO THE PRODUCT WITH INTERNET ACCESS, THE USE OF PRODUCT SHALL BE WHOLLY AT YOUR OWN RISKS. HIKVISION SHALL NOT TAKE ANY RESPONSIBILITIES FOR ABNORMAL OPERATION, PRIVACY LEAKAGE OR OTHER DAMAGES RESULTING FROM CYBER ATTACK, HACKER ATTACK, VIRUS INSPECTION, OR OTHER INTERNET SECURITY RISKS; HOWEVER, HIKVISION WILL PROVIDE TIMELY TECHNICAL SUPPORT IF REQUIRED.

SURVEILLANCE LAWS VARY BY JURISDICTION. PLEASE CHECK ALL RELEVANT LAWS IN YOUR JURISDICTION BEFORE USING THIS PRODUCT IN ORDER TO ENSURE THAT YOUR USE CONFORMS THE APPLICABLE LAW. HIKVISION SHALL NOT BE LIABLE IN THE EVENT THAT THIS PRODUCT IS USED WITH ILLEGITIMATE PURPOSES.

IN THE EVENT OF ANY CONFLICTS BETWEEN THIS MANUAL AND THE APPLICABLE LAW, THE LATER PREVAILS.

Regulatory Information

FCC Information

Please take attention that changes or modification not expressly approved by the party responsible for compliance could void the user's authority to operate the equipment.

FCC compliance: This product has been tested and found to comply with the limits for a Class B digital device, pursuant to Part 15 of the FCC Rules. These limits are designed to provide reasonable protection against harmful interference in a residential installation. This product generates, uses, and can radiate radio frequency energy and, if not installed and used in accordance with the instructions, may cause harmful interference to radio communications. However, there is no guarantee that interference will not occur in a particular installation. If this product does cause harmful interference to radio or television reception, which can be determined by turning the equipment off and on, the user is encouraged to try to correct the interference by one or more of the following measures:

1. Reorient or relocate the receiving antenna.
2. Increase the separation between the equipment and receiver.
3. Connect the equipment into an outlet on a circuit different from that to which the receiver is connected.
4. Consult the dealer or an experienced radio/TV technician for help.

FCC Conditions

This device complies with part 15 of the FCC Rules. Operation is subject to the following two conditions:

1. This device may not cause harmful interference.
2. This device must accept any interference received, including interference that may cause undesired operation.

EU Conformity Statement



This product and - if applicable - the supplied accessories too are marked with "CE" and comply therefore with the applicable harmonized European standards listed under the EMC Directive 2014/30/EU, the LVD Directive 2014/35/EU, the RoHS Directive 2011/65/EU.



2012/19/EU (WEEE directive): Products marked with this symbol cannot be disposed of as unsorted municipal waste in the European Union. For proper recycling, return this product to your local supplier upon the purchase of equivalent new equipment, or dispose of it at

designated collection points. For more information see: www.recyclethis.info



2006/66/EC (battery directive): This product contains a battery that cannot be disposed of as unsorted municipal waste in the European Union. See the product documentation for specific battery information. The battery is marked with this symbol, which may include lettering to

indicate cadmium (Cd), lead (Pb), or mercury (Hg). For proper recycling, return the battery to your supplier or to a designated collection point. For more information see: www.recyclethis.info

Industry Canada ICES-003 Compliance

Network Video Recorder Quick Start Guide

This device meets the CAN ICES-3 (B)/NMB-3(B) standards requirements.

This device complies with Industry Canada licence-exempt RSS standard(s). Operation is subject to the following two conditions:

- (1) this device may not cause interference, and
- (2) this device must accept any interference, including interference that may cause undesired operation of the device.

Le présent appareil est conforme aux CNR d'Industrie Canada applicables aux appareils radioexempts de licence. L'exploitation est autorisée aux deux conditions suivantes :

- (1) l'appareil ne doit pas produire de brouillage, et
- (2) l'utilisateur de l'appareil doit accepter tout brouillage radioélectrique subi, même si le brouillage est susceptible d'en compromettre le fonctionnement.

Under Industry Canada regulations, this radio transmitter may only operate using an antenna of a type and maximum (or lesser) gain approved for the transmitter by Industry Canada. To reduce potential radio interference to other users, the antenna type and its gain should be so chosen that the equivalent isotropically radiated power (e.i.r.p.) is not more than that necessary for successful communication.

Conformément à la réglementation d'Industrie Canada, le présent émetteur radio peut fonctionner avec une antenne d'un type et d'un gain maximal (ou inférieur) approuvé pour l'émetteur par Industrie Canada. Dans le but de réduire les risques de brouillage radioélectrique à l'intention des autres utilisateurs, il faut choisir le type d'antenne et son gain de sorte que la puissance isotrope rayonnée équivalente (p.i.r.e.) ne dépasse pas l'intensité nécessaire à l'établissement d'une communication satisfaisante.

This equipment should be installed and operated with a minimum distance 20cm between the radiator and your body.

Cet équipement doit être installé et utilisé à une distance minimale de 20 cm entre le radiateur et votre corps.

Applicable Model



This manual is applicable to the following models.

Table 1-1 Applicable Model

Series	Model
HWN-2100MH-W	HWN-2104MH-W
	HWN-2108MH-W

Symbol Conventions

The symbols that may be found in this document are defined as follows.

Symbol	Description
 Danger	Indicates a hazardous situation which, if not avoided, will or could result in death or serious injury.
 Caution	Indicates a potentially hazardous situation which, if not avoided, could result in equipment damage, data loss, performance degradation, or unexpected results.
 Note	Provides additional information to emphasize or supplement important points of the main text.

Safety Instruction

- Proper configuration of all passwords and other security settings is the responsibility of the installer and/or user.
- In the use of the product, you must be in strict compliance with the electrical safety regulations of the nation and region. Please refer to technical specifications for detailed information.
- Input voltage should meet both the SELV (Safety Extra Low Voltage) and the Limited Power Source with 100 VAC to 240 VAC or 12 VDC according to the IEC60950-1 standard. Please refer to technical specifications for detailed information.
- Do not connect several devices to one power adapter as adapter overload may cause overheating or a fire hazard.
- Please make sure that the plug is firmly connected to the power socket.
- If smoke, odor or noise rises from the device, turn off the power at once and unplug the power cable, and then please contact the service center.

Preventive and Cautionary Tips

Before connecting and operating your device, please be advised of the following tips:

- Ensure recorder is installed in a well-ventilated, dust-free environment.
- Recorder is designed for indoor use only.
- Keep all liquids away from the device.
- Ensure environmental conditions meet factory specifications.
- Ensure recorder is properly secured to a rack or shelf. Major shocks or jolts to the recorder as a result of dropping it may cause damage to the sensitive electronics within the recorder.
- Use the device in conjunction with an UPS if possible.
- Power down the recorder before connecting and disconnecting accessories and peripherals.
- A factory recommended HDD should be used for this device.
- Improper use or replacement of the battery may result in hazard of explosion. Replace with the same or equivalent type only. Dispose of used batteries according to the instructions provided by the battery manufacturer.
- When installing the device into a cabinet over 2U height, it is suggested to use rack shelf to bear the weight. If the cabinet height is over 4U, it is suggested to use slide rails or rack shelf to bear the weight.

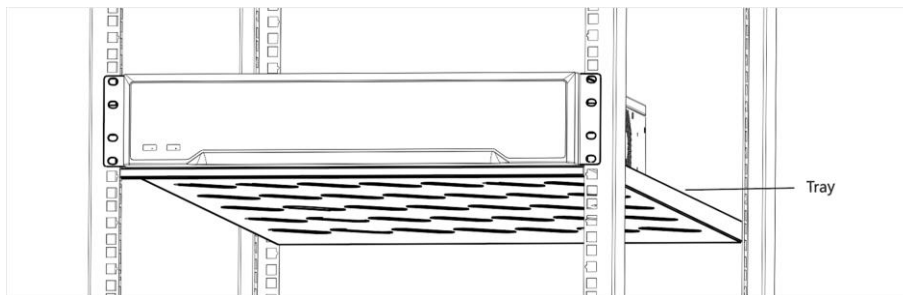

TABLE OF CONTENTS

Chapter 1 Rear Panel Interfaces Description	7
Chapter 2 Installation and Connections	8
2.1 Device Installation	8
2.2 HDD Installation	8
2.2.1 Fix-on-Bottom Installation	8
Chapter 3 Menu Operation.....	10
3.1 Startup, Shutdown and Reboot	10
3.2 Activate Your Device	10
3.3 Set Unlock Pattern.....	11
3.4 User Login	12
3.5 Network Settings	13
3.5.1 Configure General Settings	13
3.5.2 Configure Wi-Fi.....	13
3.5.3 Configure Hik-Connect	15
3.6 Add Network Cameras	15
3.6.1 Add Wi-Fi Cameras	15
3.6.2 Add IP Cameras	16
3.7 Live View.....	16
3.8 Playback.....	17
3.9 Access via Web Browser	18

Chapter 1 Rear Panel Interfaces Description

The rear panel interfaces vary with different models. Refer to the following table for common interfaces description.

Table 1-1 Common Interfaces Description of Rear Panel

Item	Description	Item	Description
AUDIO IN	RCA connector for audio input.	AUDIO OUT	RCA connector for audio output.
LINE IN	RCA connector for two-way audio input.	USB	Universal Serial Bus (USB) interface for additional device.
VGA	DB15 connector for local video output and menu display.	HDMI	HDMI interface for video output.
RS-485	RS-485 serial interface for pan/tilt unit, speed dome, etc.	RS-232	RS-232 interface for parameter configuration, or transparent channel.
LAN	RJ-45 self-adaptive Ethernet interface.	eSATA	Storage and expansion interface for record or backup.
ALARM IN/OUT	Alarm input/output interface.	GND	Ground.
Power Switch	Switch for turning on/off the device.	Power Supply	100 to 240 VAC, 48 VDC, or 12 VDC power supply, different models vary.
📶	Wi-Fi antenna interface.		

Chapter 2 Installation and Connections

2.1 Device Installation

During the device installation:

- Use brackets for rack mounting.
- Ensure ample room for audio and video cables.
- When routing cables, ensure the bend radius of the cables are no less than five times of its diameter.
- Allow at least 2 cm (≈0.75 inch) of space among racks mounted devices.
- Ensure the device is grounded.
- Environmental temperature should be within the range of -10 °C to 55 °C (14 °F to 131 °F).
- Environmental humidity should be within the range of 10% to 90%.

2.2 HDD Installation

Disconnect the power from the device before installing a hard disk drive (HDD). A factory recommended HDD should be used for this installation.

Tools Required: Screwdriver.

2.2.1 Fix-on-Bottom Installation

Fix-on-bottom installation is applicable when you need to install and fix the HDD on the device bottom.

Steps

1. Remove the cover from device by unfastening the screws on panels.

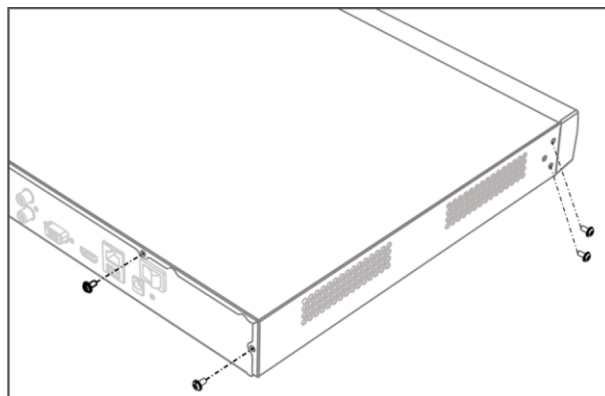

Figure 2-1 Remove Cover

2. Connect the data cable and power cable.

- 1) Connect one end of data cable to the device motherboard.
- 2) Connect the other end of data cable to HDD.
- 3) Connect one end of power cable to HDD.
- 4) Connect the other end of power cable to the device motherboard.

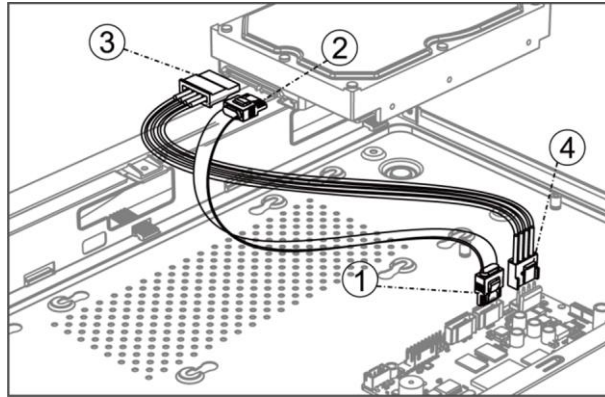

Figure 2-2 Connect Cables

3. Set the device up, match HDD screw threads with the reserved holes on the device bottom, and fix HDD with screws.

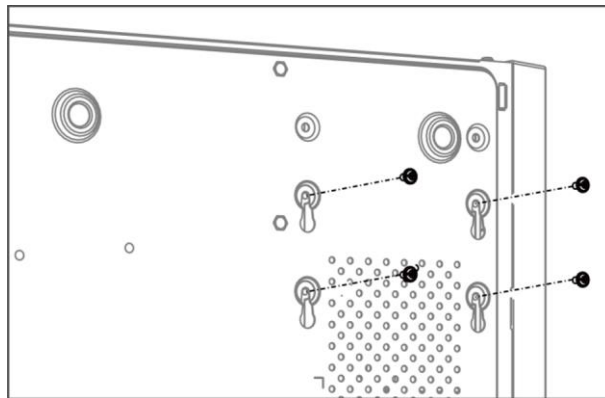

Figure 2-3 Fix HDD to Device Bottom

4. Optional: Repeat the steps above to install other HDDs.
5. Reinstall the device cover and fasten screws.

Chapter 3 Menu Operation

3.1 Startup, Shutdown and Reboot

Proper startup and shutdown procedures are crucial to expand the life of your device.

Startup Your Device

Ensure the voltage of the extra power supply satisfies the requirement, and the ground connection is working properly.

Plug the power supply into an electrical outlet. It is HIGHLY recommended that an Uninterruptible Power Supply (UPS) is used in conjunction with the device.

Press the power button on the panel. The power indicator LED would be lighted up which indicating the device begins to start up.

Shut Down Your Device

Go to **Menu** → **Shutdown**. Click **Shutdown**, and click **Yes**.

If your device has a power button on the front panel, you can also hold the power button for 3 seconds, and then enter the admin user name and password to shut down your device.

Note

Do not press the POWER button again when the system is shutting down.

Reboot Your Device

Go to **Menu** → **Shutdown**. Click **Reboot**, and your device will restart.



Figure 3-1 Startup, Shutdown and Reboot

3.2 Activate Your Device

For the first-time access, you need to activate the device by setting an admin password. No operation is allowed before activation. You can also activate the device via Web Browser, SADP or

Client Software.

Steps

1. Enter the password in **Create New Password** and **Confirm New Password**.

Warning

We highly recommend you create a strong password of your own choosing (Using a minimum of 8 characters, including at least three of the following categories: upper case letters, lower case letters, numbers, and special characters.) in order to increase the security of your product. And we recommend you reset your password regularly, especially in the high security system, resetting the password monthly or weekly can better protect your product.

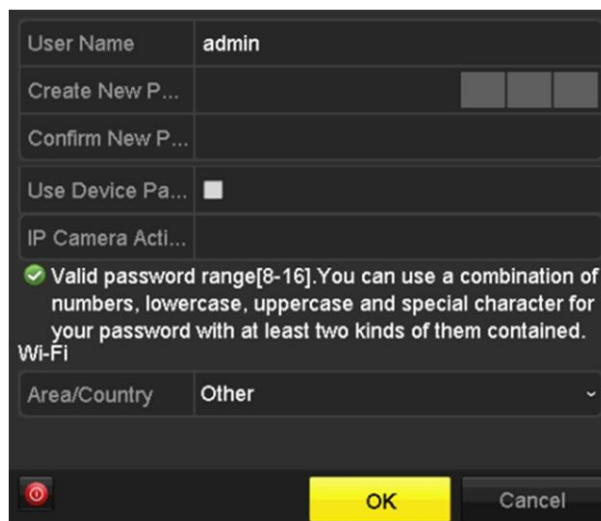

User Name	admin
Create New P...	
Confirm New P...	
Use Device Pa...	<input type="checkbox"/>
IP Camera Acti...	
✔ Valid password range[8-16]. You can use a combination of numbers, lowercase, uppercase and special character for your password with at least two kinds of them contained.	
Wi-Fi	
Area/Country	Other
<input type="button" value="OK"/> <input type="button" value="Cancel"/>	

Figure 3-2 Set Admin Password

2. Check **Use Device Password to Activate IP Camera**, or enter the password in **IP Camera Activation** to activate the IP camera(s) connected to the device.
3. Set **Area/Country**.
4. Click **OK**.

What to do next

Export the GUID file to the USB flash driver for the future password resetting.

3.3 Set Unlock Pattern

For the admin user, you can set the unlock pattern for device login after it is activated.

Steps

1. Use mouse to draw a pattern among the 9 dots on the screen. Release the mouse when the pattern is done.

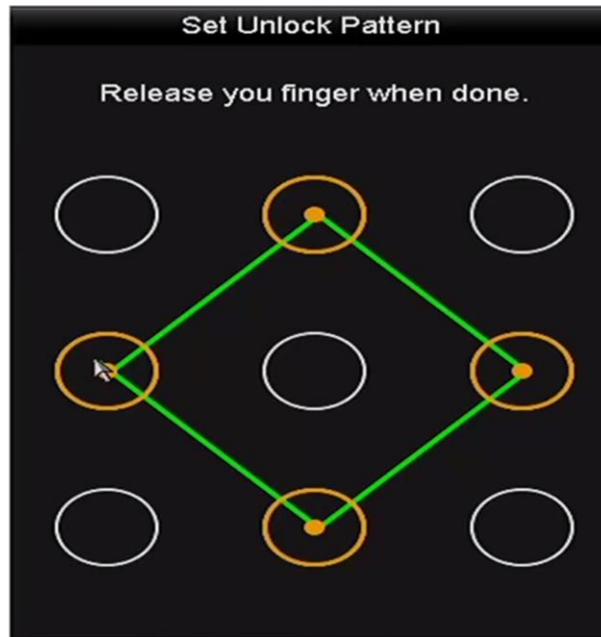



Figure 3-3 Set Unlock Pattern

 **Note**

- The pattern shall have 4 dots at least.
- Each dot can be connected for once only.

2. Draw the same pattern again to confirm it.

 **Note**

You can go to **Menu** → **Configuration** → **User**, and click  to edit or disable the unlock pattern.

3.4 User Login

You have to log in to the device before operating the menu and other functions.

Steps

1. Select a user account.
2. Enter the password for the selected user.
3. Click **Login**.

User Name	admin
Password	

Forget Pa... OK Cancel

Figure 3-4 Login

- For the admin, if you have entered the wrong password for 7 times, the account will be locked for 60 seconds.
- For the operator, if you have entered the wrong password for 5 times, the account will be locked for 60 seconds.

3.5 Network Settings

3.5.1 Configure General Settings

You shall properly configure the network settings before operating the device over network.

Steps

1. Go to **Menu** → **Configuration** → **Network** → **General**.

NIC Type			
Enable DHCP	<input checked="" type="checkbox"/>		
IPv4 Address		IPv6 Address 1	
IPv4 Subnet ...		IPv6 Address 2	
IPv4 Default G...		IPv6 Default G...	
MAC Address			
MTU(Bytes)	1500		
Enable Obtain DNS Server Addr...	<input checked="" type="checkbox"/>		
Preferred DNS Server			
Alternate DNS Server			
Internal NIC IPv4 Address			

Figure 3-5 Network Settings

2. Set the general network parameters.
3. Click **Apply**.

3.5.2 Configure Wi-Fi

The device can work as a wireless network router. Follow the steps to setup a network router.

Steps

1. Go to **Menu** → **Configuration** → **WIFI**.

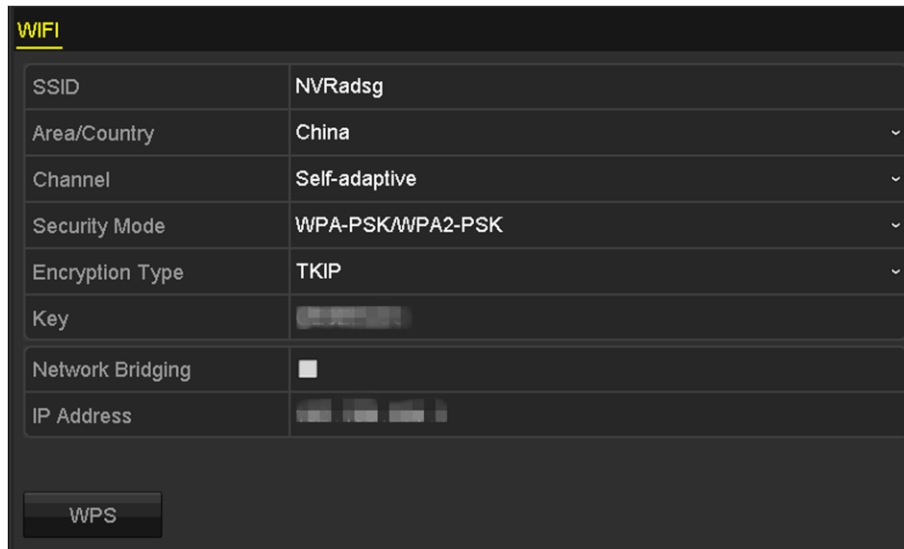

Figure 3-6 Wi-Fi Settings

2. Configure wireless network parameters, including **Network Bridging**, **SSID**, **Security Mode**, and **Key**.

Network Bridging

Enable device to create a single aggregate network from multiple communication networks or network segments.

SSID

It is the short for Service Set Identifier. SSID is the Wi-Fi name that the device provides.

Area/Country

Select where the router is used.

Channel

Select the best channel according to your situation.

Security Mode

Select the security protocol for the wireless network.

Encryption Type

It is used to protect information. TKIP and AES are selectable.

Key

Enter the encryption key.

WPS

It is the short of Wi-Fi Protected Setup. Click the button and then you can connect the wireless network without password for once.

3. Click **Apply** to save the settings.

3.5.3 Configure Hik-Connect

Hik-Connect provides mobile phone application and platform service to access and manage your connected devices, which enables you to get a convenient remote access to the surveillance system.

Steps

1. Go to **Menu** → **Configuration** → **Network** → **Platform Access**.
2. Check **Enable**. The service terms will pop up.
 - 1) Enter the verification code in **Verification Code**.
 - 2) Scan the QR code to read the service terms and privacy statement.
 - 3) Check **The Hik-Connect service will require internet access. Please read Service Terms and Privacy Statement before enabling the service** if you agree the service terms and privacy statement.
 - 4) Click **OK** to save the settings.

Note

- Hik-Connect is disabled by default.
 - The verification code is empty by default. It must contain 6 to 12 letters or numbers, and it is case sensitive.
-

3. Optional: Check **Custom** to enter the server address as your desire.
4. Optional: Check **Enable Stream Encryption**, verification code is required for remote access and live view.
5. Click **Unbind** if the device requires to unbind with the current Hik-Connect account.
6. Click **Apply**.

What to do next

After configuration, you can access and manage your devices through Hik-Connect app or website.

3.6 Add Network Cameras

Before you can get live video or record the video files, you shall add network cameras to the device.

3.6.1 Add Wi-Fi Cameras

You can use Wi-Fi match function to search Wi-Fi cameras that are not activated, and add them to the device automatically.

Select **Wi-Fi Match** from the right-click menu in live view mode, and the device will search and add Wi-Fi cameras. The process will take about 2 minutes. The Wi-Fi camera will use **IP Camera Activation Password** as its password. (Refer to **Activate Your Device**.)

Note

- It is recommended to keep the distance between Wi-Fi camera and device within 50 meters.
 - Only certain Wi-Fi camera models and versions support this function.
 - Ensure the Wi-Fi camera is powered on, not activated, and has not been connected with other devices via network cable.
-

3.6.2 Add IP Cameras

Ensure the network connection is valid and correct, and the IP camera has been activated.

Before You Start

Ensure the network connection is valid and correct, and the IP camera has been activated.

Enter the context of your task here (optional).

Steps



1. Click to select an idle window in the live view mode.
2. Click  in the center of the window.



Figure 3-7 Add IP Camera





3. Select the detected IP camera directly, or enter IP camera parameters.
4. Click **Add**.

3.7 Live View

Live view shows you the video image getting from each camera in real time. The device will automatically enter Live View mode when powered on. You can click  at the toolbar to start recording.

In the live view mode, there are icons at the right top of the screen to indicate the status of record and alarm for each channel.

Table 3-1 Description of Live View Icons

Item	Description	Item	Description
	Alarm (video loss, tampering, motion detection, VCA or sensor alarm).		Alarm and Record.
	Record (manual record, continuous record, motion detection, VCA or alarm triggered record).		Event/Exception (event and exception information, appears at the lower-left corner of the screen).

3.8 Playback

The recorded video files and pictures on HDD can be played back. Refer to the user manual for details of each playback mode.

Steps

1. Go to **Menu** → **Playback**.
2. Select the channel(s) in the channel list for playback.
3. Double click a date on the calendar.
4. Optional: Use the toolbar at the bottom to control the playing progress.
5. Optional: Select the channel(s) to execute simultaneous playback of multiple channels.



Figure 3-8 Playback

3.9 Access via Web Browser

You can get access to the device via web browser. The following web browsers are supported: Internet Explorer 6.0, Internet Explorer 7.0, Internet Explorer 8.0, Internet Explorer 9.0, Internet Explorer 10.0, Apple Safari, Mozilla Firefox, and Google Chrome. The supported resolutions include 1024*768 and above. The use of the product with Internet access might be under network security risks. For avoidance of any network attacks and information leakage, please strengthen your own protection. If the product does not work properly, please contact with your dealer or the nearest service center.

Steps

1. Open web browser, enter the IP address of the device, and press **Enter**.
2. Log in to the device.
 - If the device has not been activated, activate the device first by setting the password for the admin user account.
 - If the device is already activated, enter the user name and password to log in.
3. Follow the installation prompts to install the plug-in before viewing the live video and managing the device.

Note

- You may have to close the web browser to finish the installation of the plug-in.
 - After login, you can perform the operation and configuration of the device, including the live view, playback, log search, configuration, etc.
-



See Far, Go Further



Hik-Connect for iOS Users



Hik-Connect for Android Users